



Bâches en polyéthylène / Polyethylene tarpaulins



Tissage de haute densité, imperméable, à l'épreuve de la moisissure, facile à nettoyer, bordures renforcés avec corde, oeillets anti-corrosifs a chaque coin et tout le long de la bordure, Laminée contre rayons UV.

High density weaving, waterproof, the mold proof, easy to clean, edge reinforced with rope, anti-corrosive eyelets at each corner and along the border, Laminated against UV rays.

Tissage 8x8 po. Service Léger / 8x8 Weaving. Light duty service

Code	Dimensions	Couleur / Color	Caisse / Case	UPC
BB050-BL57	5' x 7'	Blanche / White 	40 / 1	628451924005
BB050-BL68	6' x 8'		30 / 1	628451924012
BB050-BL810	8' x 10'		20 / 1	628451924029
BB050-BL1012	10' x 12'		15 / 1	628451924036
BB050-BL1015	10' x 15'		15 / 1	628451924319
BB050-BL1216	12' x 16'		10 / 1	628451924326
BB050-BL1218	12' x 18'		10 / 1	628451924043
BB050-BL1220	12' x 20'		10 / 1	628451924333
BB050-BL1520	15' x 20'		5 / 1	628451924050
BB050-BL2030	20' x 30'		3 / 1	628451924067
BB050-BL3050	30' x 50'	1	628451924074	
BB050-BE68	6' x 8'	Bleue / Blue 	30 / 1	628451924340
BB050-BE810	8' x 10'		20 / 1	628451924357
BB050-BE1012	10' x 12'		15 / 1	628451924364
BB050-BE1218	12' x 18'		10 / 1	628451924371
BB050-BE1520	15' x 20'		5 / 1	628451924388
BB050-BE2030	20' x 30'		3 / 1	628451924395
BB050-BE3050	30' x 50'		1	628451924401

Tissage 10x10 po. Service Intense / 10x10 Weaving. Medium duty service

Code	Dimensions	Couleur / Color	Caisse / Case	UPC
BB050-CM810	8' x 10'	Camo 	20 / 1	628451927693
BB050-CM1012	10' x 12'		15 / 1	628451927709
BB050-CM1216	12' x 16'		10 / 1	628451927716
BB052-BL1520	15' x 20'	Blanche / White 	10 / 1	628451924418
BB052-BL1824	18' x 24'		4 / 1	628451924425
BB052-BL2030	20' x 30'		2 / 1	628451924432
BB052-BL2440	24' x 40'		1	628451924449
BB052-BL3050	30' x 50'		1	628451924456
BB052-BL4060	40' x 60'		1	628451924463

Tissage 14x14 po. Service Robuste / 14x14 Weaving. Heavy duty service

Code	Dimensions	Couleur / Color	Caisse / Case	UPC
BB056-GR1012	10' x 12'	Grise / Grey 	10 / 1	628451924470
BB056-GR1218	12' x 18'		5 / 1	628451924487
BB056-GR1520	15' x 20'		2 / 1	628451924081
BB056-GR1824	18' x 24'		2 / 1	628451924494
BB056-GR2030	20' x 30'		2 / 1	628451924098
BB056-GR2440	24' x 40'		2 / 1	628451924500
BB056-GR3050	30' x 50'		1	628451924517
BB056-GR4060	40' x 60'		1	628451924524

** Les dimensions du produit fini peuvent varier légèrement en raison des ourlets

** The dimensions of the finished product may vary slightly due hems.

Bâches isolantes Insulated tarpaulins



- Des couvertures légères et flexibles qui restent à plat à des températures inférieures à zéro.
- Les 2 feuilles d'isolant en mousse à cellules fermées résiste à l'humidité et garanti le maintien des propriétés isolantes maximales
- Oeillets en aluminium à tous les 3' sur le périmètre
- Matériel extérieur: bâche en polyéthylène renforcé enduit des deux côtés (tissage 8x8)
- La couverture extérieure et la mousse sont semi-translucides, permettant à la lumière de pénétrer pour un environnement de travail sûr.
- Résistant aux intempéries, à la moisissure et aux rayons UV
- Lightweight, flexible blankets that lay flat in sub-zero temperatures.
- The 2 sheets of closed cell foam insulation is moisture resistant, ensuring retention of maximum insulation properties.
- Aluminum grommets at 3' intervals around the edges
- Exterior material: Reinforced polyethylene woven coated both sides (8x8 weave)
- The outer cover and foam are semi-translucent allowing light to penetrate for a safe work environment.
- Weather, mildew and UV resistant.

Pèse environ 300 grammes / m2 / conforme à la valeur d'isolation de la norme ASTM C 518-04 d'environ R-2

Weigh approximately 300 grams/m2 / accordance with ASTM C 518-04 insulation value of approximately R-2

Code	Epaisseur / Thickness	Dimensions	Couleur / Color	UPC
BB068OR-825	3/16"	8' x 25'	Orange	628451922841
BB068OR-1220	3/16"	12' x 20'		628451922858
BB068OR-1224	3/16"	12' x 24'		628451922865

** Les dimensions du produit fini peuvent varier légèrement en raison des ourlets

** The dimensions of the finished product may vary slightly due hems.

Sangle cliquet / Ratchet Tie down

Série 1500



- Résistance à la rupture de 700 kgs (1 500 lbs)
700 kgs (1 500 lbs) breaking limit.
- Crochets robustes en acier recouvert de caoutchouc
Full size rubber coated "S" hooks
- Dimensions : 25mm (1") x 4,57 m (15 pi)
- Sangle de couleur / Webbing color : Orange
- **Paquet de 4 sangles complète**
4 full Ratchet Tie Down kit

Code	Capacité / Capacity	Ensemble de / Kit of	Carton	UPC
BKR1501	700 kgs / 1500 Lbs	1 pc	25	628451922667
BKR1504	700 kgs / 1500 Lbs	4 pcs	10	628451926207

Sangle cliquet / Ratchet Tie Down

Série 3000



- Résistance à la rupture de 1 400 kgs (3 000 lbs)
1 400 kgs (3 000 lbs) breaking limit.
- Crochets en double J extra robuste
Heavy duty double J hooks
- Dimensions : 25mm (1") x 5,28 m (16 pi)
- Sangles de couleur / Webbing color : Jaune / Yellow
- **Paquet de 2 sangles complète**
2 full Ratchet Tie Down kit

Code	Capacité / Capacity	Ensemble de / Kit of	Carton	UPC
BKR3002	1400 Kgs / 3000 Lbs	2 pcs	10	628451926214

Sangle cliquet / Ratchet Tie Down

Série 10000



- Résistance à la rupture de 4 500 kgs (10 000 lbs)
4 500 kgs (10 000 lbs) breaking limit.
- Crochets en double J extra robuste
Heavy duty double J hooks
- Dimensions : 50mm (2") x 9,15 m (30 pi)
- Sangles de couleur / Webbing color : Jaune / Yellow
- **Paquet de 1 sangle complète**
1 full Ratchet Tie Down kit

Code	Capacité / Capacity	Ensemble de / Kit of	Carton	UPC
BKR10001	4500 Kgs / 10000 Lbs	1 pc	10	628451926221

Sangles élastiques / Bungee cords

Série S

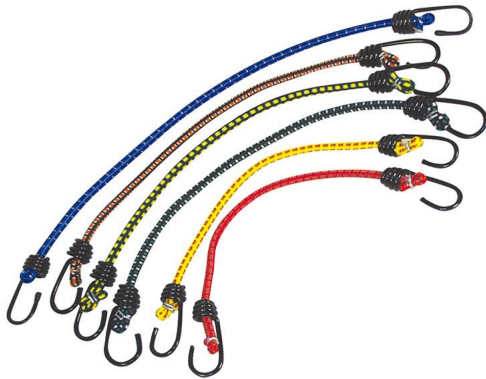

- Service léger / Light service
- Sangles élastiques économiques de qualité / Quality Assorted Bungee Cords
- Revêtement double pour une protection contre l'usure et les rayons UV / Protective coating resists corrosion and UV resistant.
- Crochets en acier recouvert de plastique / plastic coated hooks.

Code	Diamètre / Diameter	Longueur / Length	Carton	UPC
BSB0812	8mm (5/16``)	305mm (12``)	10	628451926306
BSB0818	8mm (5/16``)	457mm (18``)	10	628451926313
BSB0824	8mm (5/16``)	610mm (24``)	10	628451926320
BSB1030	10mm (3/8``)	762mm (30``)	10	628451926337
BSB1036	10mm (3/8``)	914mm (36``)	10	628451926344

Sangles élastiques / Bungee cords

Série S



- Service léger / Light service
- Sangles élastiques économiques de qualité / Quality Assorted Bungee Cords
- Protection contre l'usure et les rayons UV / Protective coating resists corrosion and UV resistant.
- Crochets en acier recouvert de plastique / plastic coated hooks.
- Ensemble de / Kit of :
(12) 4 x 12" - 2 x 18" - 2 x 24" - 2 x 30" - 2 x 36"

Code produit	Couleur	Ensemble de / Kit of	Carton	UPC
BSB-12	Assortie / Assorted	12 pcs	30	628451922544

Sangles à bâche EPDM / EPDM tarpaulin straps

Série R



•Service léger / Light service

•Résistance aux températures extrêmes et rayons UV
Resistance to extreme temperatures and UV rays

•Crochets en S en acier zingué résistant à la rouille
Zinc coated hook rust resistant

Code	Couleur / Color	Longueur / Length	Carton	UPC
BRB005	Noir / Black	127mm (5``)	10	628451926375
BRB010	Noir / Black	279mm (11``)	10	628451926382
BRB015	Noir / Black	381mm (15``)	10	628451926399
BRB021	Noir / Black	533mm (21``)	10	628451926405
BRB031	Noir / Black	787mm (31``)	10	628451926412

Chaîne de transport / Transport Chain

Grade G70 - Chromaté jaune / Yellow Chromate



Emballage individuelle
Retail Packaging



Avec crochets grappin à manille
With grab hooks

Code produit	Dimenisons	Charge de travail Working Load	Carton	UPC
C8G7-20	(8mm) 5/16" x (6.1m) 20'	(2,132kgs) 4,700lbs	1	628451927976
C10G7-20	(10mm) 3/8" x (6.1m) 20'	(2,994kgs) 6,600lbs	1	628451927983
C13G7-20	(13mm) 1/2" x (6.1m) 20'	(5,126kgs) 11,300lbs	1	628451927990

Broche à poule / Poultry netting

Acier galvanisé, hexagonal / Galvanized hex wire

Code	Grillage Mesh	Hauteur Height	Longueur Length	Calibre Gage	UPC	BBP
BBP2425	1"	24"	25'	22G	628451924531	
BBP2450	1"	24"	50'	22G	628451924548	
BBP24100	1"	24"	100'	22G	628451924555	
BBP3625	1"	36"	25'	22G	628451924562	
BBP3650	1"	36"	50'	22G	628451924579	
BBP36100	1"	36"	100'	22G	628451924586	
BBP4825	1"	48"	25'	22G	628451924593	
BBP4850	1"	48"	50'	22G	628451924609	
BBP48100	1"	48"	100'	22G	628451924616	
BBP60100	1"	60"	100'	22G	628451924623	
BBP72100	1"	72"	100'	22G	628451924630	

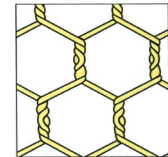

Toile métallique / Hardware mesh

Acier galvanisé après soudure / Galvanized after welding

Code	Grillage Mesh	Hauteur Height	Longueur Length	Calibre Gage	UPC	BTM
BTM03-36-06	1/8"	36"	6'	27G	628451924647	
BTM03-36-25	1/8"	36"	25'	27G	628451924654	
BTM03-36-50	1/8"	36"	50'	27G	628451924661	
BTM06-24-50	1/4"	24"	50'	23G	628451924678	
BTM06-36-06	1/4"	36"	6'	23G	628451924692	
BTM06-36-25	1/4"	36"	25'	23G	628451924708	
BTM06-36-50	1/4"	36"	50'	23G	628451924715	
BTM10-36-06	3/8"	36"	6'	21G	628451924722	
BTM10-36-50	3/8"	36"	50'	21G	628451924739	
BTM13-24-50	1/2"	24"	50'	20G	628451924746	
BTM13-30-50	1/2"	30"	50'	20G	628451924753	
BTM13-36-06	1/2"	36"	6'	20G	628451924760	
BTM13-36-25	1/2"	36"	25'	20G	628451924777	
BTM13-36-50	1/2"	36"	50'	20G	628451924784	
BTM13-48-50	1/2"	48"	50'	20G	628451924791	
BTM19-36-06	3/4"	36"	6'	19G	628451924807	
BTM19-36-25	3/4"	36"	25'	19G	628451924814	
BTM19-36-100	3/4"	36"	100'	19G	628451924821	
BTM25-36-06	1"	36"	6'	19G	628451924838	
BTM25-36-25	1"	36"	25'	19G	628451924845	
BTM25-36-50	1"	36"	50'	19G	628451924852	
BTM25-36-100	1"	36"	100'	19G	628451924869	

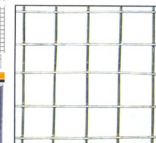

Toile métallique / Hardware mesh

Acier galvanisé après soudure / Galvanized after welding

Code	Grillage Mesh	Hauteur Height	Longueur Length	Calibre Gage	UPC
BTM212-36-25	2" x 2"	36"	25'	14G	628451927815
BTM212-48-50	2" x 2"	48"	50'	14G	628451927822

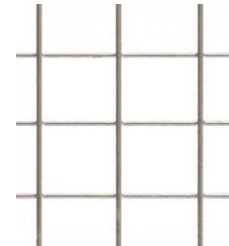

Code	Grillage Mesh	Hauteur Height	Longueur Length	Calibre Gage	UPC
BTM214-36-25	2" x 4"	36"	25'	14G	628451927839
BTM214-48-50	2" x 4"	48"	50'	14G	628451927846



Grillage de plastique / Plastic Fence

Maille en vinyle résistant aux UV / Vinyl Hardware Mesh UV Resistant

Code	Grillage Mesh	Hauteur Height	Longueur Length	Couleur Color	UPC
BTP19-36-15	3/4"	36"	15'	Noir / Black	628451927853

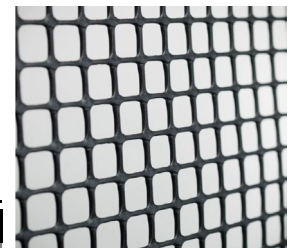

Fil Acier Armature / Iron Wire

Fil recuit en rouleaux compact Noire 16G / Black 16G Wire coil to fit STD tie wire

Code	Longueur Length	Poids weight	Carton	UPC
ASWG16	450'	3.1/8 lbs	16	628451927860



Poteau en «T» / "T" Post

En acier percé. Peint. Léger. Construit en acier thermolaqué

Drilled steel. Painted. Lightweight. Constructed of powder-coated steel



Code	Diam.	Hauteur Height	Couleur Color	UPC
T6	1 1/4"	6'	Vert / Green	628451930006
T7	1 1/4"	7'	Vert / Green	628451930013
T8	1 1/4"	8'	Vert / Green	628451930020



Support de tablette / Shelf bracket

Acier émaillé / Enamelled steel

BSP002



Code	Dimensions	Couleur / Color	Carton	UPC
BSP002-BL34	3" x 4"	Blanc / White	20	628451924876
BSP002-BL45	4" x 5"	Blanc / White	20	628451924883
BSP002-BL56	5" x 6"	Blanc / White	20	628451924890
BSP002-BL68	6" x 8"	Blanc / White	20	628451924906
BSP002-BL79	7" x 9"	Blanc / White	20	628451924913
BSP002-BL810	8" x 10"	Blanc / White	20	628451924920
BSP002-BL1012	10" x 12"	Blanc / White	20	628451924937
BSP002-BL1214	12" x 14"	Blanc / White	20	628451924944

Support de tablette ultra robuste / Heavy duty shelf support

Acier émaillé / Enamelled steel

BSP120 - 125



120



125

Code	Dimensions	Couleur / Color	Carton	UPC
BSP120-BL812	8" x 12"	Blanc / White	10	628451924951
BSP120-BL1016	10" x 16"	Blanc / White	10	628451924968
BSP120-BL1320	13" x 20"	Blanc / White	10	628451924975
BSP125-BL1113	11" x 13"	Blanc / White	10	628451923152

Coulisse Auto-Fermante / Self-closing slide

Série BES



- Enrubanné en paire avec code à barre
- 1 pair taped with barcode
- Capacité / Capacity : 75 Lbs

Code	Longueur / Length	Couleur / Color	Carton	UPC
BES300-WH	300mm (12")	Blanche / White	10	628451926849
BES350-WH	350mm (14")	Blanche / White	10	628451926863
BES400-WH	400mm (16")	Blanche / White	10	628451926887
BES450-WH	450mm (18")	Blanche / White	10	628451926900
BES500-WH	500mm (20")	Blanche / White	10	628451926924
BES550-WH	550mm (22")	Blanche / White	10	628451926948

Coulisse pleine extension / Full extension slide

Série BFES



- Ensaché en paire avec code à barre
- 1 pair per bag with barcode
- Capacité / Capacity : 100 Lbs

Code	Longueur / Length	Couleur / Color	Carton	UPC
BFES300-ZC	300mm (12")	Zinc	10	628451926702
BFES350-ZC	350mm (14")	Zinc	10	628451926726
BFES400-ZC	400mm (16")	Zinc	10	628451926740
BFES450-ZC	450mm (18")	Zinc	10	628451926764
BFES500-ZC	500mm (20")	Zinc	10	628451926788
BFES550-ZC	550mm (22")	Zinc	10	628451926801
BFES600-ZC	600mm (24")	Zinc	10	628451926818

Pleine extension avec fermeture lente / Full extension slide with Soft closing

Série BFES-ZC



- Ensaché en paire avec code à barre
- 1 pair per bag with barcode
- Capacité / Capacity : 75 Lbs

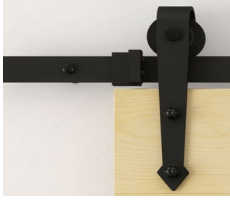

Code	Longueur / Length	Couleur / Color	Carton	UPC
BFES300ZC-SC	300mm (12")	Zinc	10	628451928003
BFES350ZC-SC	350mm (14")	Zinc	10	628451928027
BFES400ZC-SC	400mm (16")	Zinc	10	628451928041
BFES450ZC-SC	450mm (18")	Zinc	10	628451928065
BFES500ZC-SC	500mm (20")	Zinc	10	628451928089
BFES550ZC-SC	550mm (22")	Zinc	10	628451928102

**Quincaillerie style « Rustique » pour portes coulissantes
Barn door hardware « Rustic » style for interior sliding doors**

Style	Descriptions	Dimensions	Couleur / Color	Code	UPC
	<i>Ensemble complet avec roulements, rail et accessoires. Complete package with bearings, rail caps and accessories.</i>	6.6 pi/ft.	Noir Rustique Rustic Black	KBD9876U-NR	628451926009
		8 pi/ft.		KBD9878U-NR	628451926047
	<i>Ensemble complet avec roulements, rail et accessoires. Complete package with bearings, rail caps and accessories.</i>	6.6 pi/ft.	Noir Rustique Rustic Black	KBD9876A-NR	628451926023

* 2 poignées et 1 loquet ci-dessous sont inclus dans les ensembles ci-dessus mais aussi disponible séparément

* 2 handles and 1 latch below are included in the sets above but also available separately

Style	Descriptions	Couleur / Color	Code	UPC
	<i>Poignée Noire surface 164x25x5mm Black surface handle 164x25x5mm</i>	Noir Rustique Rustic Black	BDHA9870-NR	628451930068
	<i>Poignée Noire encastré 165x53x2.8mm Black recessed handle 165x53x2.8mm</i>	Noir Rustique Rustic Black	BDHA9871-NR	628451930075
	<i>Loquet Noir 145x41x24mm Black Door hook 145x41x24mm</i>	Noir Rustique Rustic Black	BDHO9880-NR	628451930082

**Quincaillerie style « Rustique » pour portes coulissantes (Econo)
(Econo) Barn door hardware « Rustic » style for interior sliding doors**

**** Sans poignées et loquet - Without handles and Latch ****

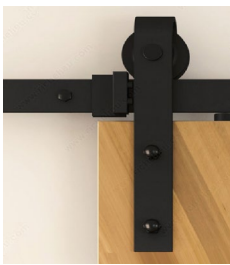
	<i>Ensemble complet avec roulements, rail et accessoires Embouts : Carrées Complete package with bearings, rail caps and accessories: Square</i>	6.6 pi/ft.	Noir Rustique Rustic Black	KBD0076U-NR	628451927303
---	--	------------	-------------------------------	-------------	--------------

Quincaillerie pour portes pliantes Hardware for folding doors



Couleur / Color
Blanche / White

1 pièce par sac / 1 pc per bag

Code	Longueur / Length	Carton	UPC
BFTRACK-24BL	23-3/4" / 603mm	20	728451920806
BFTRACK-30BL	29-3/4" / 756mm	20	728451920813
BFTRACK-36BL	35-3/4" / 908mm	20	728451920820
BFTRACK-48BL	47-3/4" / 1213mm	20	728451920837
BFTRACK-60BL	59-3/4" / 1518mm	20	728451920844
BFTRACK-72BL	71-3/4" / 1822mm	20	728451920851

Quincaillerie pour mécanisme de porte pliante / Hardware for folding door mechanism



Code	Description	Carton	UPC
BFKIT-A38	Ensemble quincaillerie pour porte pliante (perçage /drilling 3/8" / 10mm) Hardware for folding door mechanism	50	628451920809

Pentures de porte pliante / Folding door hinges



Code	Description	Carton	UPC
BCH147-C2M1	Penture plaqué Zinc avec vis 63.5 x 41mm Zinc plated hinge with screws	50	628451923121



Code	Description	Carton	UPC
BCH148-C2DM1	Penture plaqué laiton avec vis 76 x 31mm Brass plated hinge with screws	50	628451923138

Chaise et table pliante Folding chair and table



Descriptions	Dimensions	Couleur / Color	Code	UPC
Table Pliante plastique avec base en acier Foldind plastic table with steel frame	180 x 76 x 74cm	Blanc / White	BFDT7230-BL	628451922643
Chaise plastique avec base en acier (boite 4) Plastic chair with steel frame (4 carton)	60 x 48 x 87cm	Blanc / White	BFC150-BL	628451923237

Chevalet Sawhorse



Dessus en bois de 2" x 4" et pieds en tuyaux galvanisés de 7/8"

Wooden top measuring 2" X 4" and galvanized 7/8" tubing

Descriptions	Dimensions	Capacité Capacity	Code	UPC
Chevalet Super Banc, acier et bois Super Banc Sawhorse - Steel and Wood	36" L x 26" H	907 Kgs (2,000lbs) / Pair	CSB3626	628451930037

Serie 201

Poignées rondes / Knob



- Pour porte de 1-3/16po à 1-61/64po (30-50mm) Door thickness
- Pêne ajustable : 2-3/8po et 2-3/4po (60mm et 70mm) Latch adjustment
- Pêne à 4 voies / 4 way latch
- Emballage thermoformé "Blister"Pack

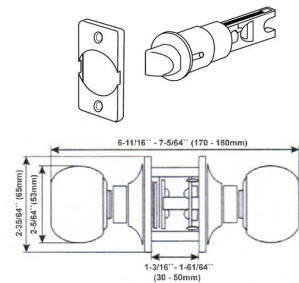

Code produit	Fonction / Function	Couleur / Color	Carton	UPC
BP201PS-SS	Passage	Stainless	24 / 12 / 1	628451910008
BP201PV-SS	Privée / Privacy	Stainless	24 / 12 / 1	628451910015
BP201EN-SS	Entrée / Entrance	Stainless	24 / 12 / 1	628451910022
BP201PS-LT	Passage	Laiton Poli / Brass	24 / 12 / 1	628451910039
BP201PV-LT	Privée / Privacy	Laiton Poli / Brass	24 / 12 / 1	628451910046
BP201EN-LT	Entrée / Entrance	Laiton Poli / Brass	24 / 12 / 1	628451910053
BP201PS-OB	Passage	Bronze	24 / 12 / 1	628451910060
BP201PV-OB	Privée / Privacy	Bronze	24 / 12 / 1	628451910077
BP201EN-OB	Entrée / Entrance	Bronze	24 / 12 / 1	628451910084
BP201PS-NR	Passage	Noir Mat / Black	24 / 12 / 1	628451927655
BP201PV-NR	Privée / Privacy	Noir Mat / Black	24 / 12 / 1	628451927662
BP201EN-NR	Entrée / Entrance	Noir Mat / Black	24 / 12 / 1	628451927679

Serie 221

Levier "réversibles" / "reversible" Lever



- Pour porte de 1-3/16po à 1-61/64po (30-50mm) Door thickness
- Pêne ajustable : 2-3/8po et 2-3/4po (60mm et 70mm) Latch adjustment
- Pêne à 4 voies / 4 way latch
- Emballage thermoformé "Blister"Pack

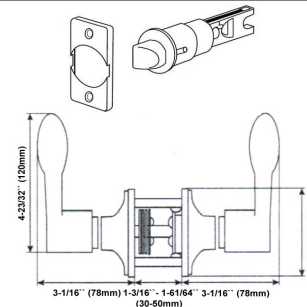

Code produit	Fonction / Function	Couleur / Color	Carton	UPC
BP221PS-SS	Passage	Stainless	24 / 6 / 1	628451910091
BP221PV-SS	Privée / Privacy	Stainless	24 / 6 / 1	628451910107
BP221EN-SS	Entrée / Entrance	Stainless	24 / 6 / 1	628451910114
BP221PS-LT	Passage	Laiton Poli / Brass	24 / 6 / 1	628451910121
BP221PV-LT	Privée / Privacy	Laiton Poli / Brass	24 / 6 / 1	628451910138
BP221EN-LT	Entrée / Entrance	Laiton Poli / Brass	24 / 6 / 1	628451910145
BP221PS-OB	Passage	Bronze	24 / 6 / 1	628451910152
BP221PV-OB	Privée / Privacy	Bronze	24 / 6 / 1	628451910169
BP221EN-OB	Entrée / Entrance	Bronze	24 / 6 / 1	628451910176
BP221PS-NR	Passage	Noir Mat / Black	24 / 6 / 1	628451910183
BP221PV-NR	Privée / Privacy	Noir Mat / Black	24 / 6 / 1	628451910190
BP221EN-NR	Entrée / Entrance	Noir Mat / Black	24 / 6 / 1	628451910206

Serie 241

Levier / Lever



- Pour porte de 1-3/16po à 1-61/64po (30-50mm) Door thickness
- Pêne ajustable : 2-3/8po et 2-3/4po (60mm et 70mm) Latch adjustment
- Pêne à 4 voies / 4 way latch
- Emballage thermoformé "Blister"Pack

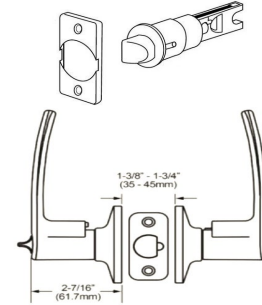

Code produit	Fonction / Function	Couleur / Color	Carton	UPC
BP241PS-SS	Passage	Stainless	24 / 6 / 1	628451910213
BP241PV-SS	Privée / Privacy	Stainless	24 / 6 / 1	628451910220
BP241EN-SS	Entrée / Entrance	Stainless	24 / 6 / 1	628451910237
BP241PS-NR	Passage	Noir Mat / Black	24 / 6 / 1	628451910244
BP241PV-NR	Privée / Privacy	Noir Mat / Black	24 / 6 / 1	628451910251
BP241EN-NR	Entrée / Entrance	Noir Mat / Black	24 / 6 / 1	628451910268

Serie 251

Levier / Lever



- Pour porte de 1-3/16po à 1-61/64po (30-50mm) Door thickness
- Pêne ajustable : 2-3/8po et 2-3/4po (60mm et 70mm) Latch adjustment
- Pêne à 4 voies / 4 way latch
- Emballage thermoformé "Blister"Pack

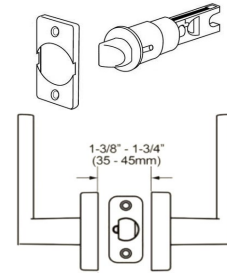

Code produit	Fonction / Function	Couleur / Color	Carton	UPC
BP251PS-SS	Passage	Stainless	24 / 6 / 1	628451910275
BP251PV-SS	Privée / Privacy	Stainless	24 / 6 / 1	628451910282
BP251EN-SS	Entrée / Entrance	Stainless	24 / 6 / 1	628451910299
BP251PS-NR	Passage	Noir Mat / Black	24 / 6 / 1	628451910305
BP251PV-NR	Privée / Privacy	Noir Mat / Black	24 / 6 / 1	628451910312
BP251EN-NR	Entrée / Entrance	Noir Mat / Black	24 / 6 / 1	628451910329

Serie 301

Pêne dormant / Dead bolt



- Pour porte de 1-3/16po à 1-61/64po (30-50mm) Door thickness
- Pêne ajustable : 2-3/8po et 2-3/4po (60mm et 70mm) Latch adjustment
- Pêne à 4 voies / 4 way latch
- Emballage thermoformé "Blister"Pack

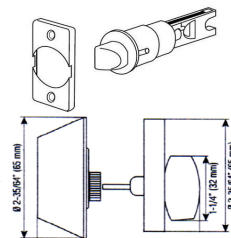

Code produit	Fonction / Function	Couleur / Color	Carton	UPC
BP301PD-SS	Cylindre simple	Stainless	24 / 6 / 1	628451910336
BP301PD-LT	Cylindre simple	Laiton Poli / Brass	24 / 6 / 1	628451910343
BP301PD-OB	Cylindre simple	Bronze	24 / 6 / 1	628451910350
BP301PD-NR	Cylindre simple	Noir Mat / Black	24 / 6 / 1	628451910367

Serie 521 - 621

Serrure d'entrée / Handleset

- Pour porte de 1-3/16po à 1-61/64po
(30-50mm) Door thickness
- Pêne ajustable : 2-3/8po et 2-3/4po
(60mm et 70mm) Latch adjustment
- Pêne à 4 voies / 4 way latch

BP521

BP621



Code produit	Fonction / Function	Couleur / Color	Carton	UPC
BP521EN-SS	Entrée / Entrance	Stainless	8 / 1	628451910374
BP621EN-SS	Entrée / Entrance	Stainless	8 / 1	628451910381
BP621EN-OB	Entrée / Entrance	Bronze	8 / 1	628451910398
BP621EN-NR	Entrée / Entrance	Noir Mat / Black	8 / 1	628451927686

Support utilitaire pliant pour rangement Folding utility rack for storage



Code	Dimensions	Capacité / Capacity	Carton	UPC
SUPM3048-G	30" - 48" / 76 - 122 cm	300 lb (136 kg)	10	628451923251

Étagère de rangement robuste à 5 tablettes 5-Level Heavy Duty Steel Shelving



Code	Dimensions	Couleur / Color	Carton	UPC
E4272-NR	48" L x 24" P x 72" H - 4000Lbs	Noir / Black	1	628451930044

Sac à rebuts en polyéthylène blanc White Polyethylene dumpster bag



Descriptions	Dimensions	Carton	Code
Sac à rebuts en polyéthylène / Polyethylene dumpster bag	75 x 110 cm - 30" x 43"	500 / 100	DB75110

Ventilateur de conduit Duct air booster



Ventilateur de conduit, structure en acier galvanisé, Moteur et cordon d'alimentation de 2 mètres certifié UL / Duct air booster, galvanized duct, Motor and 2 meters cord are UL certified

Diamètre / Diameter	CFM	Code	UPC
4"	100	DB4	628451922766
5"	165	DB5	628451922773
6"	240	DB6	628451922780

Lampadaire extérieur Outdoor light post



Descriptions

Couleur / Color

Code

UPC

Lampadaire extérieur, 2.2 M de Hauteur , 3 lumieres Certifié UL 3-Light Post Light, 2.2 M height, UL Certified	Noir / Black	LA86/3-NR	628451922964
Lampadaire extérieur, 2.2 M de Hauteur , 1 lumiere Certifié UL 1-Light Post Light, 2.2 M height, UL Certified	Noir / Black	LA86/1-NR	628451923268
Poteau pour lumière extérieur (3" diam. x 78" H) Outdoor light post	Noir / Black	PLA78/3-NR	628451923275
Lampadaire extérieur avec adaptateur 3" / Outdoor lamp with 3" adaptor	Noir / Black	LA29-NR	628451923282

Seau de plastique blanc White plastic bucket



Descriptions	Code	Carton
Seau Blanc 13.25L 3.5G White Bucket	B3.5G-W	25
Couvercle en plastique Plastic Bucket Lid	B3.5GW-C	50



Descriptions	Code	Carton
Seau Blanc 18.9L 5G White Bucket	B5G-W	25
Couvercle en plastique avec bec verseur / Plastic Bucket Lid with Pouring Spout	B5GW-C	50

** Possibilité de personnaliser avec votre logo sous certaines conditions.

** Ability to customize with your logo under certain conditions.

Fournitures de déménagement Moving Supplies

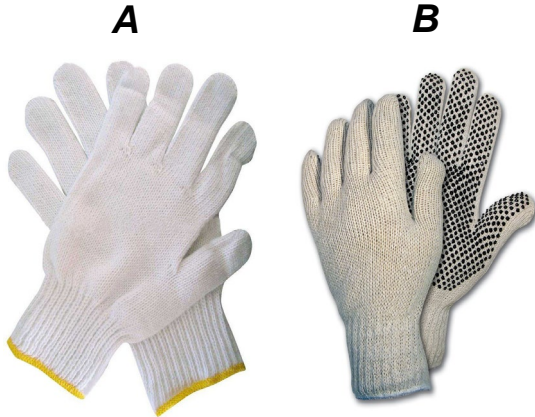

Descriptions	Code	Carton	UPC
Couverture de déménagement en tissu Fabric Moving Blanket 72" x 40" - 183cm x 102cm	UB7240	24	628451929031
Couverture de déménagement en tissu Fabric Moving Blanket 72" x 80" - 183cm x 203cm	UB7280	12	628451923114
Sangles et harnais de déménagement ajustable pour 2 personnes Adjustable straps and moving harness for 2 people	HAR-03	10	628451923244

Gants de coton
Cotton gloves

- Mélange 60% polyester et 40% coton
- 60% Polyester and 40% cotton blend
- Emballages 12 paires / 12 Pairs pack

	Dimension	Code	Carton	UPC
A	Medium	CG12-M	50	628451922872
	Large	CG12-L	50	628451922889
B	Medium - PVC	WCP12-M	50	628451922896
	Large - PVC	WCP12-L	50	628451922902

Gants tout usage enduit de nitrile
Nitrile coated general purpose gloves

- 40% Polyester / 60% Nitrile
- Emballages 10 paires / 10 Pairs pack

	Dimension	Code	Carton	UPC
	Medium	PN10-M	20	628451923909
	Large	PN10-L	20	628451929024

Gants de travail en cuir de vache
Cow Split Leather Work Gloves

- Cuir refendu-coton / Split leather-cotton

	Dimension	Code	Carton	UPC
	Large	LG1-L	25	628451927426
• Emballage: 1 paire / 1 Pair pack				

	Dimension	Code	Carton	UPC
	Large	LG6-L	10	628451927433
• Emballage: 6 paires / 6 Pairs pack				

Serre-Joints à gachette Trigger clamps

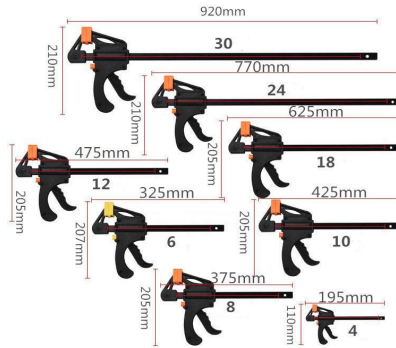

Dimension	Code	UPC
4"	TC-195	628451923039
6"	TC-325	628451923046
8"	TC-375	628451923053
10"	TC-425	628451923060
12"	TC-475	628451923077
18"	TC-625	628451923084
24"	TC-770	628451923091
30"	TC-920	628451923107

Serre-Joints Clamps



Dimension	Code	UPC
2"	HC-65	628451922971
3"	HC-92	628451922988
4"	HC-105	628451922995
4.5"	HC-110	628451923008
6"	HC-168	628451923015
9"	HC-216	628451923022

Ruban à mesurer Measuring tape



- Ruban de 16' ou 25' disponible / 16' or 25' ribbon available
- Boîtier en caoutchouc / rubber case
- Courroie de retenue en nylon / Nylon retaining strap
- Mesures Métrique, Impériale avec fractions
Metric, Imperial measurements with fractions



Dimension	Code	Carton	UPC
16'	MT16MIF	10	628451929000
25'	MT25MIF	10	628451929017

**Ventilateur de plafond
Ceiling Fan**

Descriptions	Code	UPC
<i>Ventilateur de plafond 48" diamètre, Moteur couleur Noire et 3 pales en Bois véritable couleur Noyer, Télécommande 5 vitesses avec fonction renverse et minuterie. Ceiling fan 48 " diameter, Black motor and 3 blades in real wood Walnut color, 5-speed remote control with reverse function and timer.</i>	<i>CF48-BK/WN</i>	<i>628451920007</i>
<i>Ventilateur de plafond 48" diamètre, Moteur couleur Nickel Satiné et 3 pales en Bois véritable couleur érable, Télécommande 5 vitesses avec fonction renverse et minuterie. Ceiling fan 48 " diameter, Satin nickel motor and 3 blades in real wood Maple color, 5-speed remote control with reverse function and timer.</i>	<i>CF48-SN/MP</i>	<i>628451927600</i>

Membrane Géotextile Geotextile membrane



Descriptions

Dimensions

Couleur / Color

Code

UPC

Épaisseur - Thickness 0.9oz / Garantie limitée 10ans - Limited warranty 10years

<p>Membrane couvre-sol géotextile économique en polypropylène non tissé. Contrôle les mauvaises herbes et aide à conserver l'humidité du sol. Economic geotextile ground cover membrane in black non-woven polypropylene. Controls weeds and helps conserve soil moisture</p>	36" x 24'	Noir / Black	MG093624	628451920014
	36" x 50'	Noir / Black	MG093650	628451920021
	36" x 100'	Noir / Black	MG0936100	628451920038

Épaisseur - Thickness 1.75oz / Garantie limitée 20ans - Limited warranty 20years

<p>Membrane conçue pour les rocailles, les allées, les patios et les jardins de plantes vivaces. Empêche les paillis pour jardin de se mélanger avec la terre. Stabilise le sol, arrête les mauvaises herbes, contrôle l'érosion. / Membrane designed for rock gardens, alleys, patios and perennial gardens. Prevents garden mulch from mixing with soil. Stabilizes soil and erosion.</p>	36" x 50'	Noir / Black	MG173650	628451920045
	48" x 100'	Noir / Black	MG1748100	628451920052

Épaisseur - Thickness 4.5oz / Garantie à vie limitée - Limited lifetime warranty

<p>Membrane supérieure. Excellent produit pour mettre sous les pavés. Tissage très robuste. Traitement UV. offre une durabilité accrue et un contrôle supérieur des mauvaises herbes. / Superior quality membrane. Excellent product to put under paving stones. Very robust weaving. UV treatment. offers increased durability and superior weed control.</p>	36" x 50'	Noir / Black	MG253650	628451920069
	48" x 100'	Noir / Black	MG2548100	628451920076

Agrafe multi usages / Gardening Pins

Longueur / Length : 6"

Paquet / Pack : 10 pcs

Code : PQ610

UPC : 628451930051

Construction en acier durable, capable de fixer des tissus paysagers
Durable steel construction; able to secure landscape fabrics



Chaise zéro gravité Zero gravity chair



Descriptions	Dimensions	Couleur / Color	Code	UPC
Chaise zéro gravité / Zero gravity chair	165 x 65 x 110cm 65" x 25.5" x 43.3"	Noir / Black	CZG6532-NR	628451922797
Chaise zéro gravité / Zero gravity chair	165 x 65 x 110cm 65" x 25.5" x 43.3"	Rouge / Red	CZG6532-RG	628451922803
Porte-gobelet Simple / Simple cup holder	30 x 16 x 5cm 12" x 6.5" x 2"	Noir / Black	CZG6565-NR	628451922827
Porte-gobelet Double / Double cup holder	38 x 24 x 6cm 15" x 9" x 2.4"	Noir / Black	CZG6593-NR	628451922834

Chaise Adirondack empilable en résine Adirondack Stackable Resin Chair

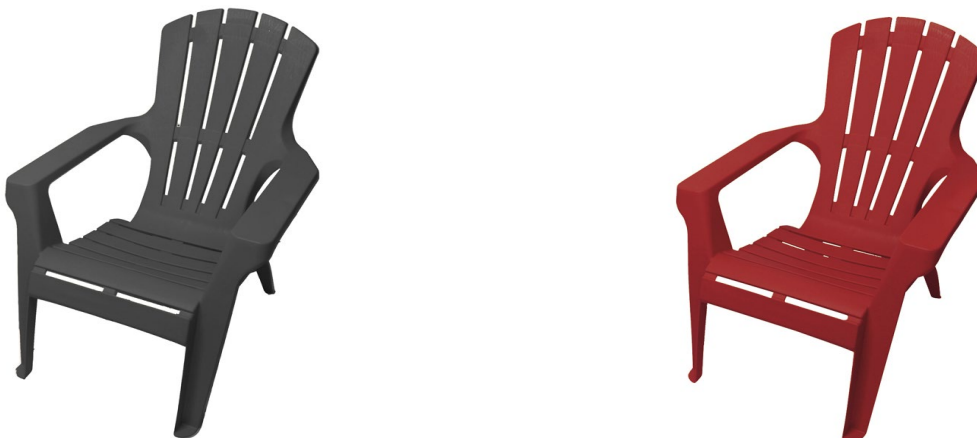

Descriptions	Dimensions	Couleur / Color	Code	UPC
Chaise Adirondack Chair Cap : 150 Kgs / 330 Lbs	87.6 x 76.2 x 92 cm 34.5" x 30" x 36" H	Gris / Grey	CA6548-GC	628451927631
Chaise Adirondack Chair Cap : 150 Kgs / 330 Lbs	87.6 x 76.2 x 92 cm 34.5" x 30" x 36" H	Rouge / Red	CA6548-RG	628451927648

Brouette / wheelbarrow



Code	Specifications	UPC
3256	Couleur / Color : Jaune / Yellow	628451927334
	Roue / Wheel:3.50-8	
	Dimensions:L/H/C/A/B/h	
	1380/605/540/820/655/205mm	
	Cap:130 kg	
Volume (CBF) : 5		



Code	Specifications	UPC
6453	Couleur / Color : Rouge / Red	628451927341
	Roue / Wheel:4.00-8	
	Dimensions:L/H/C/A/B/h	
	1510/480/525/985/700/260mm	
	Cap:180kg	
Volume (CBF) : 6		

Diable / Hand Truck



Code	Specifications	UPC
1805	Couleur / Color : Rouge / Red	628451927969
	Roue / Wheel10"X3.50"	
	Dimensions:L/W/H	
	1310/550/460mm	
	Cap :200kg	



Code	Specifications	UPC
1946	Couleur / Color : Noir / Black	628451927358
	Roue / Wheel10"X3.50-4	
	Dimensions:L/W/H	
	1735/540/490mm	
	Cap :200kg	

Foyer / Firepit



119



124



264



489



495

Descriptions	Dimensions	Couleur / Color	Code	UPC
Foyer extérieur avec grille de cuisson Outdoor firepit with cooking grate	32" x 32" x 20" H	Noir / Black	119	628451927921
Foyer extérieur avec grille de cuisson Outdoor firepit with cooking grate	29.5" x 29.5" x 20" H	Noir / Black	124	628451927945
Foyer extérieur Outdoor firepit	26" x 22" x 43.5" H	Noir / Black	264	628451927372
Foyer extérieur avec grille de cuisson Outdoor firepit with cooking grate	29.5" x 49.5" H	Noir / Black	489	628451927617
Foyer extérieur avec grille de cuisson Outdoor firepit with cooking grate	40" x 71" H	Noir / Black	495	628451927938

Parasol / Chauffe Patio Umbrella / Patio Heater



PH01B

1419 - 1421

2220

4615

Code

Descriptions

Dimensions

Couleur / Color

UPC

Code	Descriptions	Dimensions	Couleur / Color	UPC
CE PH01B	Chauffe Patio / Patio Heater - Propane Interrupteur automatique / Safety switch Housse incluse / cover included	32" diam x 88" H 46,000 BTU	Noir / Black - Stainless	628451927952
1419-RG	Parasol inclinable sans base Tilt-g Patio Umbrella without base	2.1m diam. x 2.4m H 7' diam x 8' H	Rouge / Red	628451927532
1419-GR			Gris f. / D. grey	628451927549
1419-BE			Beige	628451927556
1421-RG	Parasol inclinable sans base Tilt-g Patio Umbrella without base	2.7m diam. x 2.4m H 9' diam x 8' H	Rouge / Red	628451927389
1421-GR			Gris f. / D. grey	628451927396
1421-BE			Beige	628451927563
BA14	Base (eau / water)	12 Kgs / 26 Lbs	Noir / Black	628451927587
2220-RG	Parasol excentré avec base en croix Offset Patio Umbrella with cross base	2.7m diam. x 2.4m H 9' diam x 8' H	Rouge / Red	628451927402
2220-GR			Gris f. / D. grey	628451927419
2220-BE			Beige	628451927570
BA22	Base (ciment)	48 Kgs / 105 Lbs	Noir / Black	628451927594
4615-NR	Abris Soleil / Gazebo	10' x 10' x 10' H	Noir / Black	628451927627

Clôture à neige en plastique Plastic snow fence

Série SF

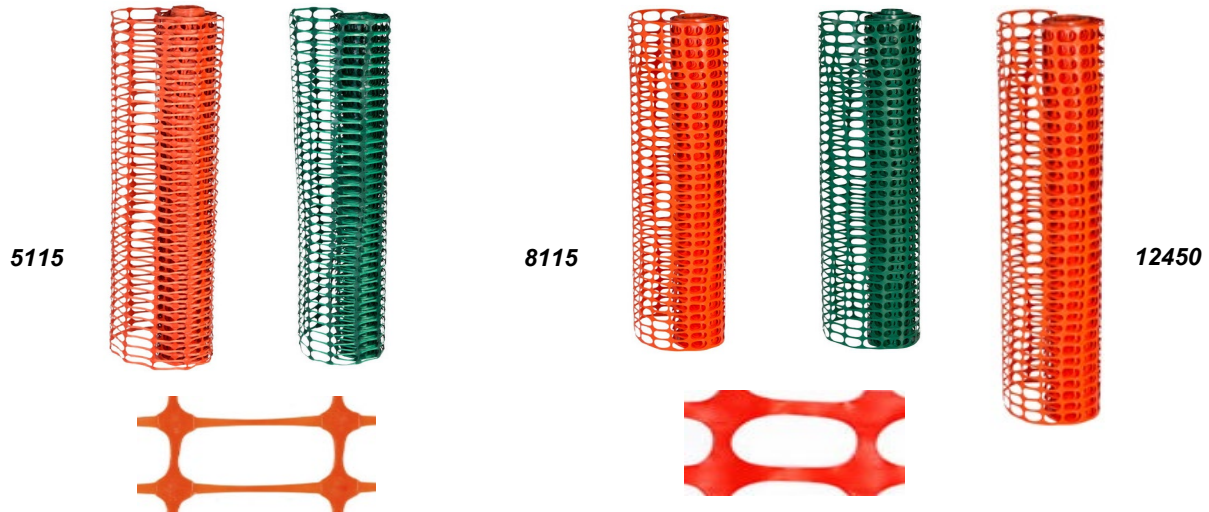

Code	Lbs	Dimensions	Couleur / Color	UPC
SF5115-07	5	1 m x 15 m (39.4"x49.2 pi)	Orange	628451927440
SF5115-63	5	1 m x 15 m (39.4"x49.2 pi)	Vert / Green	628451927457
SF8115-07	8	1 m x 15 m (39.4"x49.2 pi)	Orange	628451927464
SF8115-63	8	1 m x 15 m (39.4"x49.2 pi)	Vert / Green	628451927471
SF12450-07	12	1.22m x 15.24 m (48"x50 pi)	Orange	628451927488

Clôture de construction Construction fence

Série CF

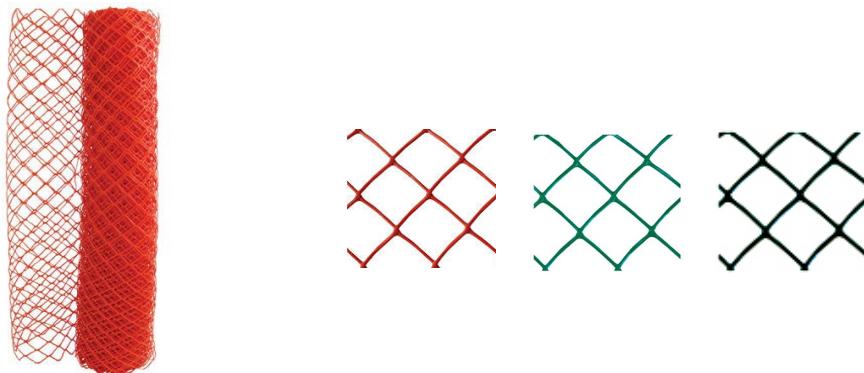

Code	Lbs	Dimensions	Couleur / Color	UPC
CF14450-07	14	1.22m x 15.24 m (48"x50 pi)	Orange	628451927495
CF14450-63	14	1.22m x 15.24 m (48"x50 pi)	Vert / Green	628451927907
CF14450-95	14	1.22m x 15.24 m (48"x50 pi)	Noir / Black	628451927914

Jute tout usage All-Purpose Burlap

- Sert à protéger les arbres et arbustes de la pluie verglaçante et de la neige lourde
- Toile protège aussi du sel de la rue et du vent
- Helps protect your bushes and shrubs from freezing rain and snow
- Acts as an additional barrier against road salt and wind damage



Code	Dimensions	Calibre	UPC
BU4010	1 m x 3 m (40" x 9.8 pi)	7oz	628451927723
BU4025	1 m x 7.5 m (40" x 25 pi)	7oz	628451927730
BU4050	1 m x 15.2 m (40" x 50 pi)	7oz	628451927501
BU40100	1 m x 30.4 m (40" x 100 pi)	7oz	628451927518
BU40300	1 m x 92 m (40" x 300 pi)	7oz	628451927525

Couvre Pelouse Lawn Cover



- Lavable / Washable
- 12 Ancrages inclus
12 Anchors included



Pour une protection hivernale efficace / For effective winter protection

Code	Dimensions	Couleur Color	UPC
LC525	5' H x 25' L	Vert / Green	628451927884

Balustre / Baluster



Balustres pour rampe de terrasse et rampe d'escaliers 3/4" (19mm) de diamètre enduit de peinture en poudre qui résistera à la décoloration et la rouille.

Balusters for patio railing and stair railing 3/4 " (19mm) in diameter coated with powder paint that will resist fading and rust.

Code	Dimensions - diam x h	Paquet / Pack	Couleur / Color	UPC
BA26NR10	3/4" (19mm) x 26" (66cm)	10	Noir / Black	628451927747
BA32NR10	3/4" (19mm) x 32" (81.3cm)	10	Noir / Black	628451927754
BA36NR10	3/4" (19mm) x 36" (91.4cm)	10	Noir / Black	628451927761

* Ensemble (10 tubes par carton) Adapteurs AS19NR, ASE19NR non inclus

* Set (10 tubes per box) Adaptors AS19NR, ASE19NR not included

Code	Dimensions - diam x h	Boîte	Couleur / Color	UPC
BA32NR30	3/4" (19mm) x 32" (81.3mm)	30	Noir / Black	628451927778

* Ensemble contracteur (30 tubes par carton) avec 60 adaptateurs AS19NR pour application en surface

* Contractor set (30 tubes per box) with 60 adapters AS19NR for surface application included

Adpteurs / Adaptors



AS19NR

Vis inclus / screw included



ASE19NR



AR24NR

Vis inclus / screw included



ARE24NR

Code	Descriptions	Paquet / Pack	UPC
AS19NR20	Droite - en surface / Straight - surface mount	20	628451927785
ASE19NR20	Pour escalier en surface / Stair Rail surface mount	20	628451927792
AR24NR4	Connecteur de garde-corps / Railing Connector	4	628451927808
ARE24NR4	Connecteur de garde-corps d'escalier / Stair Rail Connector	4	628451927891